

Senčeni deli imajo možnost vseh barv.
Zasjenjeni dijelovi imaju mogućnost svih boja.
Shaded parts are available in all of the colours.

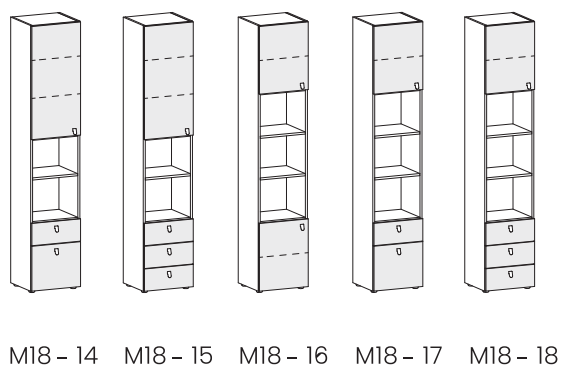

OSNOVNI ELEMENTI / OSNOVNI ELEMENTI / BASIC ELEMENTS

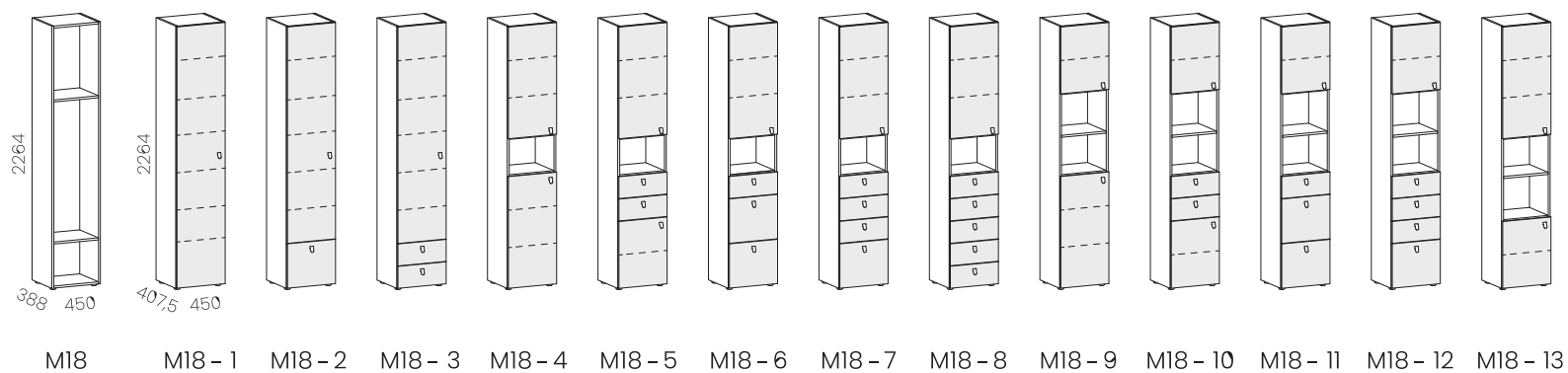

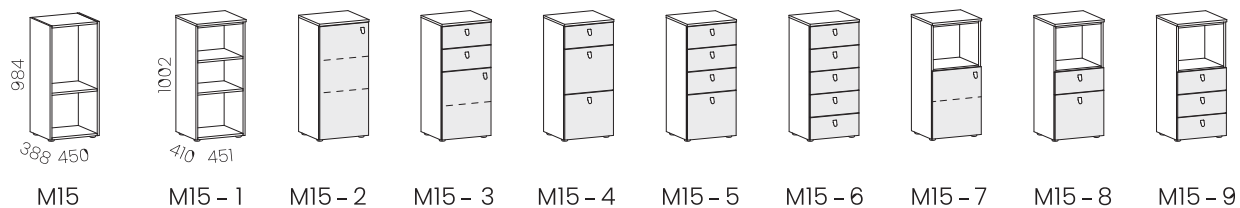
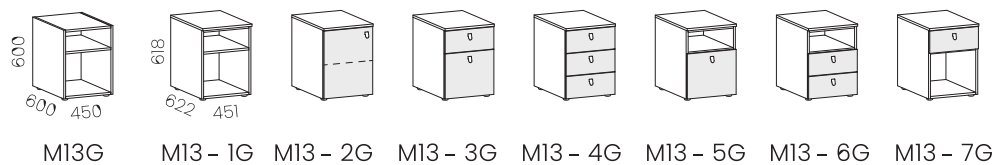
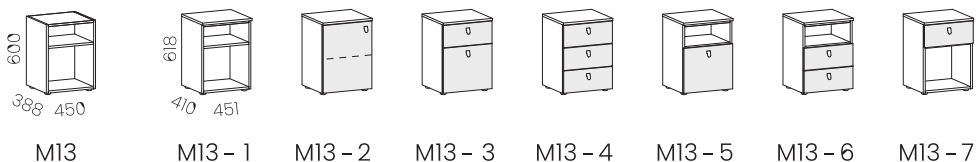
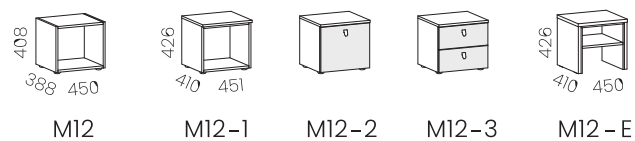
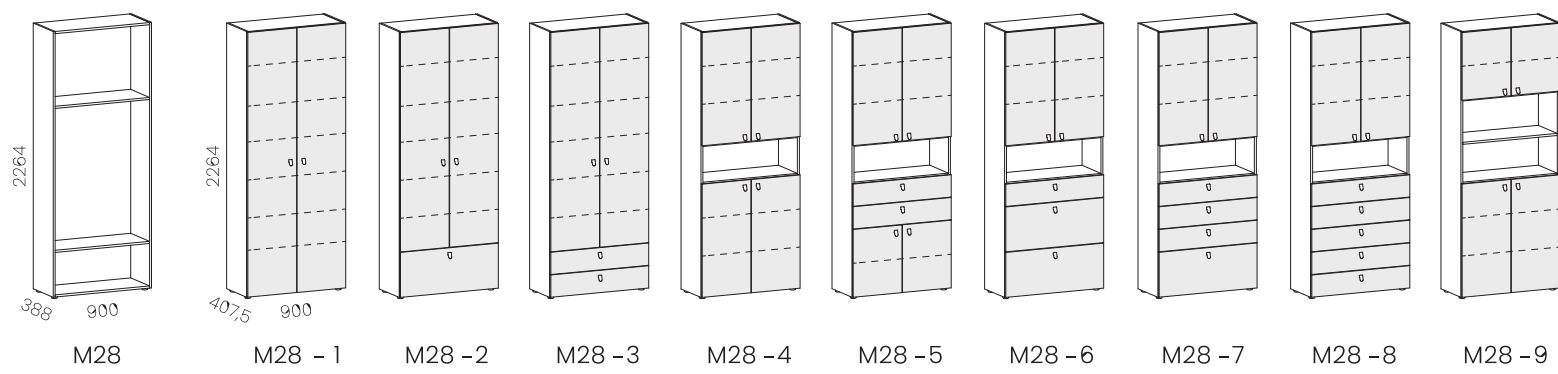
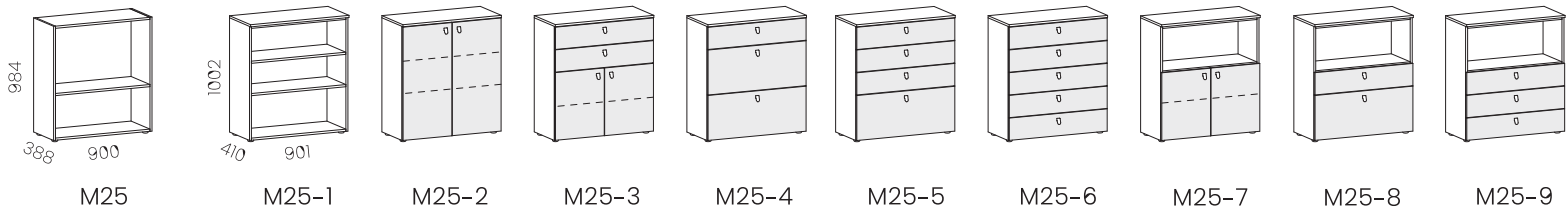
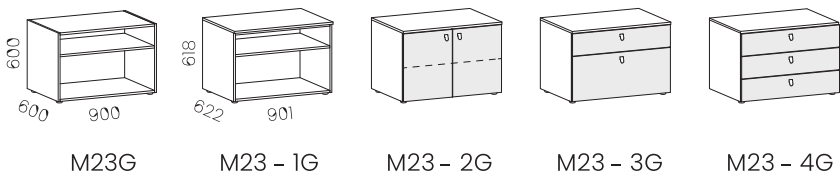
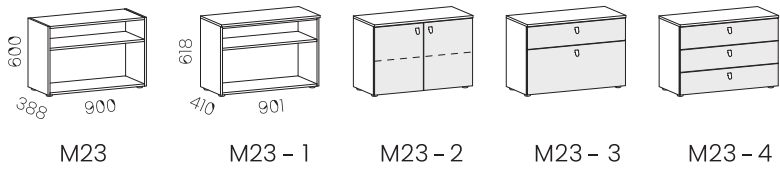
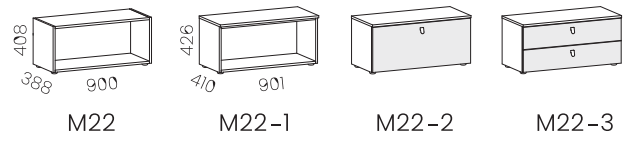

GARDEROBNI ELEMENTI / GARDEROBNI ELEMENTI / WARDROBES

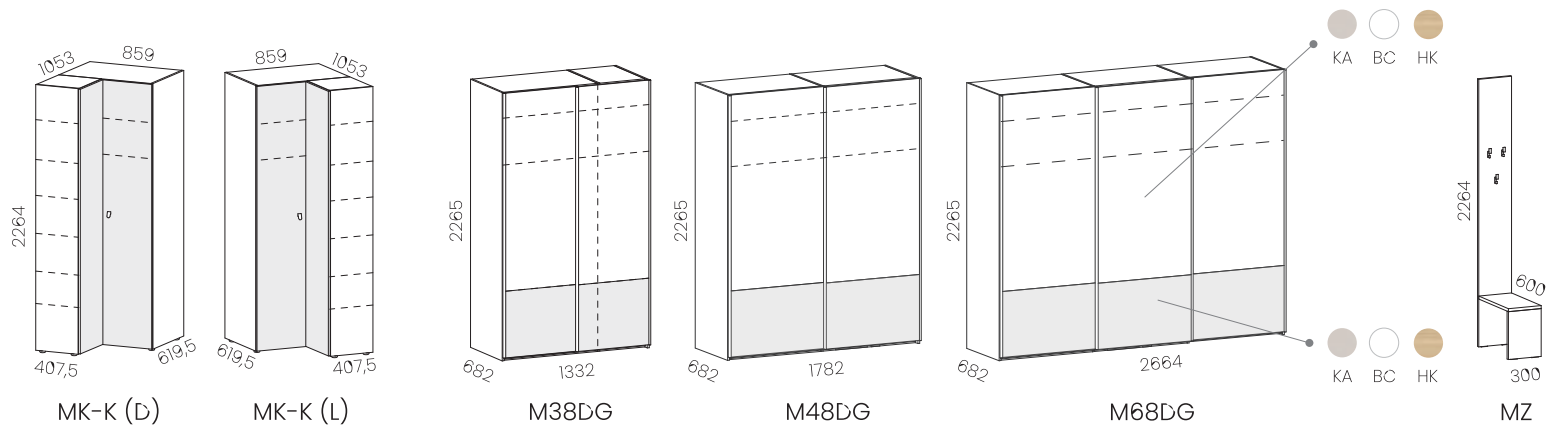
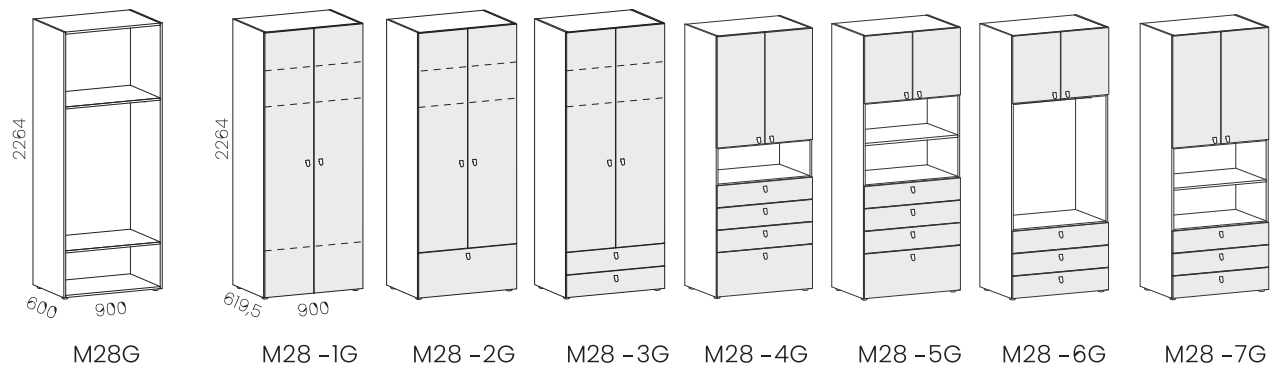
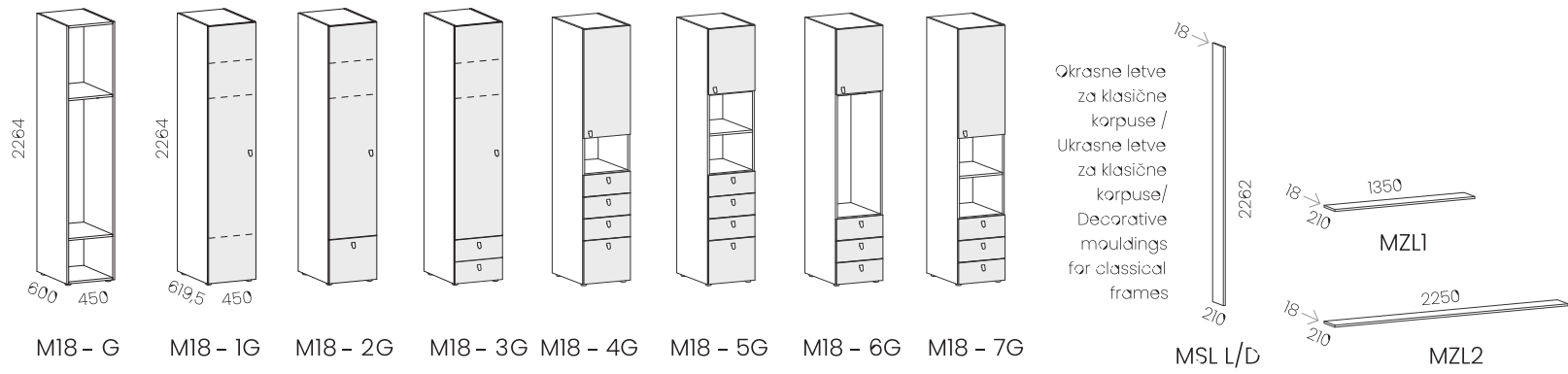

ni možna uporaba dodatkov garderobnih omar
/ nije moguće koristiti dodatke garderobnih ormara
/ it is not possible to use wardrobe interior elements

DODATKI GARDEROBNIH OMAR / DODACI GARDEROBNIH ORMARA / WARDROBE INTERIOR ELEMENTS

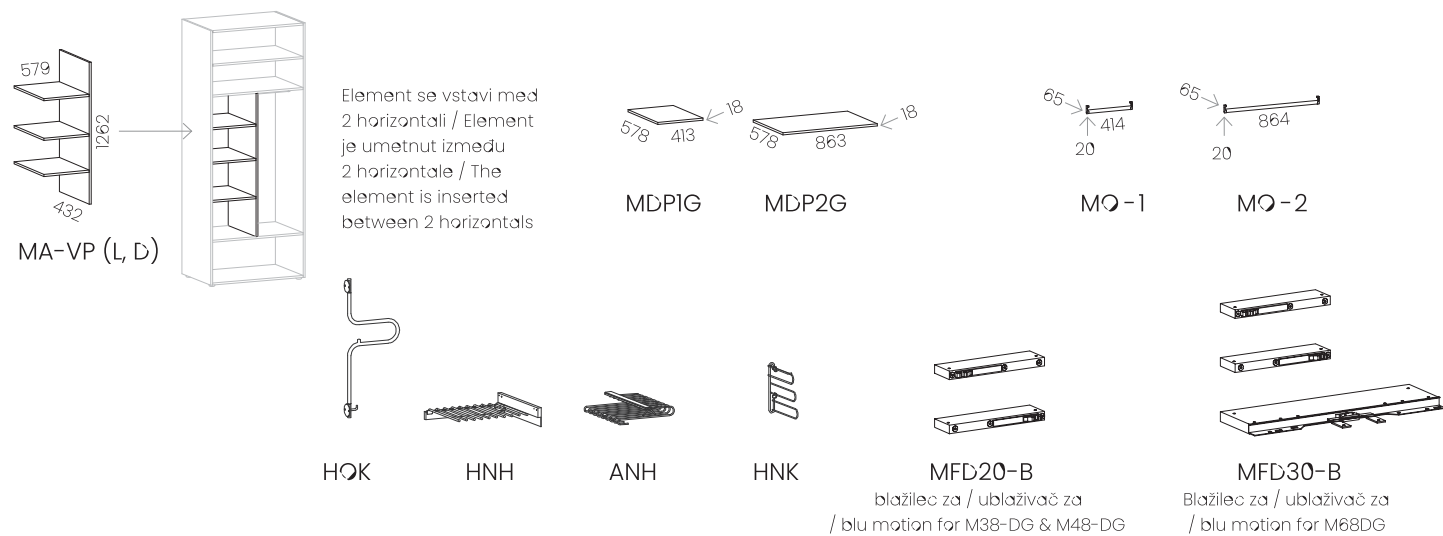

DODATNI ELEMENTI / DODATNI ELEMENTI / SUPPLEMENTAL ELEMENTS

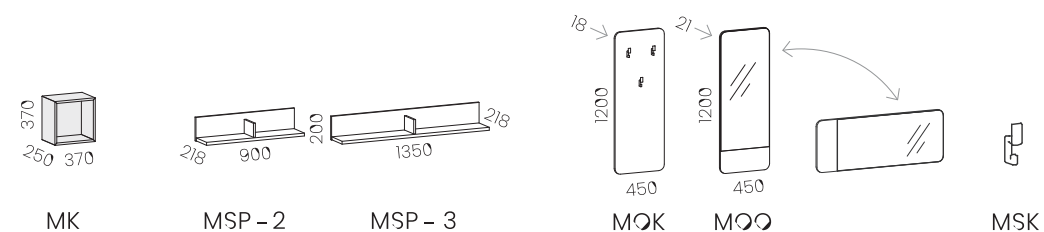

SVETILA / SVJETILJKE / LIGHTS



A - SBI (1xLT+1xI5W TR) A - ST (2xLS+1xI5W TR)

LT - svetilo s stikalom na dotik • svjetiljka sa prekidačem na dodir • light with touch switch

LS - svetilo s senzorjem gibanja • svjetiljka sa senzorom pokreta • light with motion sensor

TR - vtič s transformatorjem in kablom • utikač sa transformatorom i kablom • plug with transformer and cable

VIŠEĆI ELEMENTI / VIŠEĆI ELEMENTI / WALL MOUNTED ELEMENTS

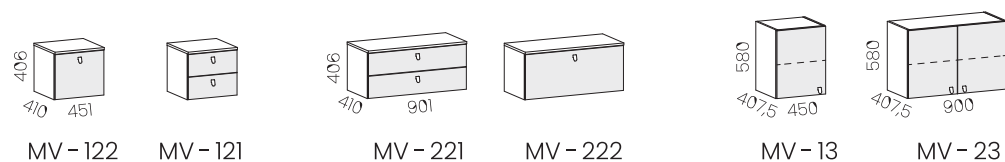

FRONTE / VRATA I LADICE / DOORS AND DRAWERS

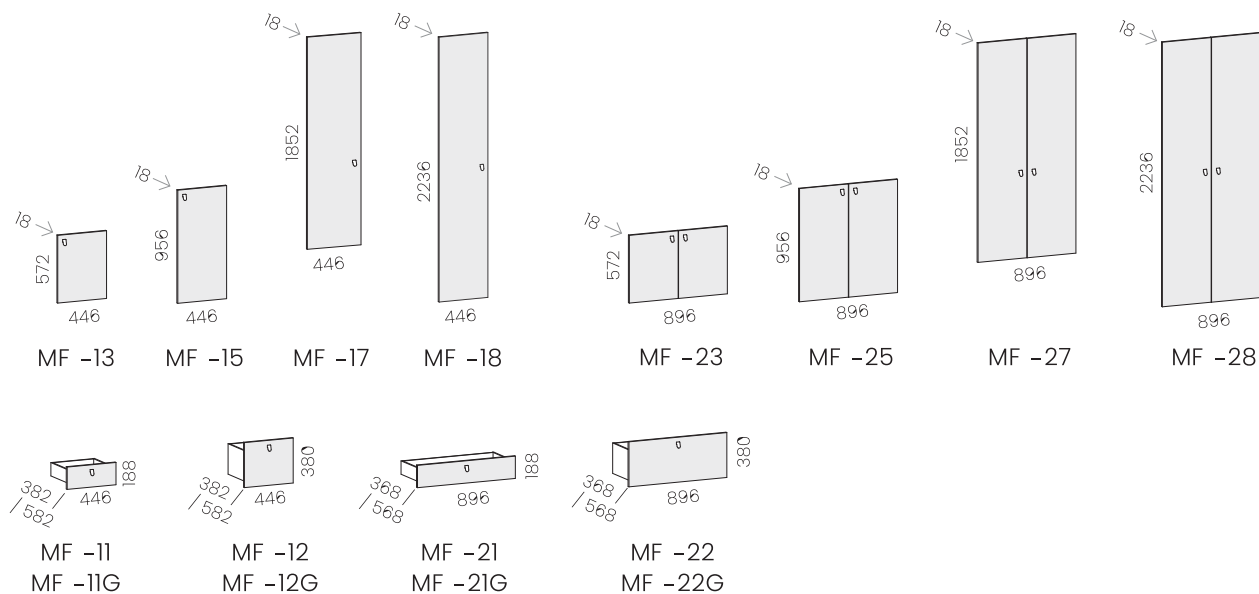

POKRIVNE PLOŠČE / POKRIVNE PLOČE / TOP PANELS

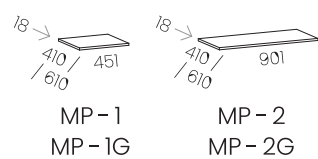

DODATNE POLICE / DODATNE POLICE / ADDITIONAL SHELVES

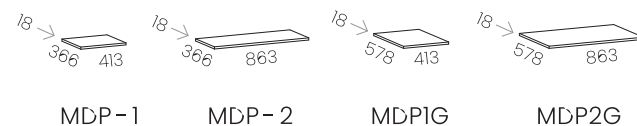

VMESNE POLICE / VEZNA POLICE / BRIDGE SHELVES

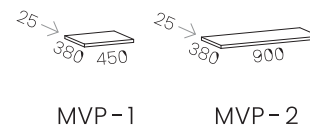

POSTELJE / KREVETI / BEDS

Oblazinjena vzglavna končnica v treh barvah tkanine / Tapecirano uzglavje u tri boja tkanine / Upholstered headboard in three colours of fabrics

T24 T26 T36

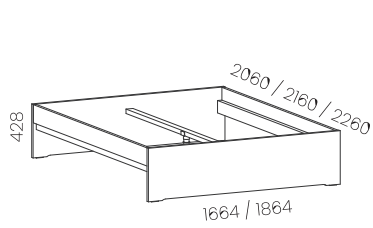

ML 160N / 200, 210, 220
ML 180N / 200, 210, 220

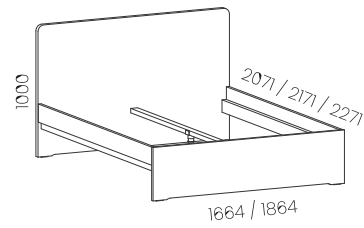

ML 160V / 200, 210, 220
ML 180V / 200, 210, 220

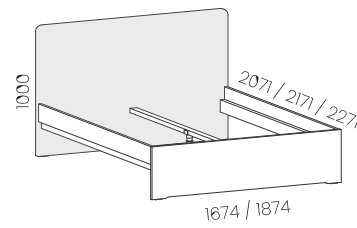

ML 160T / 200, 210, 220
ML 180T / 200, 210, 220

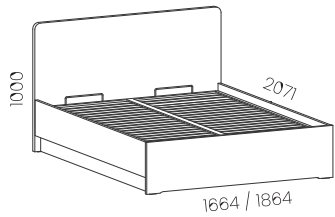

ML 160D / 200
ML 180D / 200

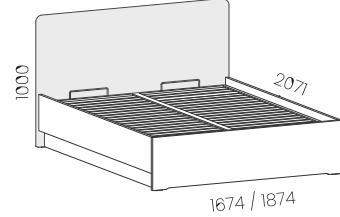

ML 160DT / 200
ML 180DT / 200

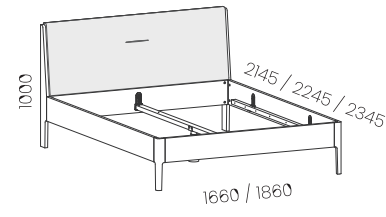

ML 160KT / 200, 210, 220
ML 180KT / 200, 210, 220



Nastavljivost dna po višini
Mijenjanje visine dna kreveta
Bottom changing height

Samo v lesnem dekorju!
Samo u drvenom dekoru!
Only in wood decor!

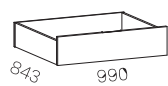

ML-P

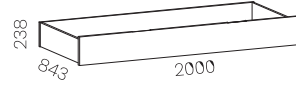

ML-D

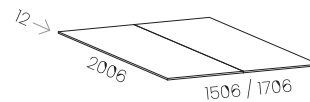

MTZ 160 / 200
MTZ 180 / 200

zaščitno dno pri dvizni postelji
zaštitno dno na krevetu za podizanje
protective bottom for lifting bed

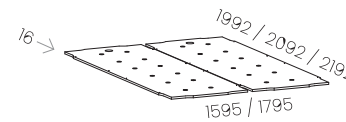

BLED 160 / 200, 210, 220
BLED 180 / 200, 210, 220

PISALNE MIZE / PISAČI STOLOVI / WRITING DESKS

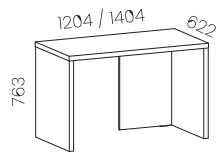

MPM1Q (L, D)
MPM2Q (L, D)

na sliki je L izvedba
na sliki je L izvedba
the picture shows L version

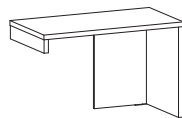

MPMIN (L, D)
MPM2N (L, D)

na sliki je L izvedba
na sliki je L izvedba
the picture shows L version

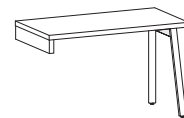

MPMINK (L, D)
MPM2NK (L, D)

na sliki je L izvedba
na sliki je L izvedba
the picture shows L version



MPMIK
MPM2K

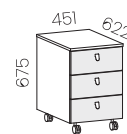

MP

SESTAVNI DELI PISALNIH MIZ PO MERI / KOMPONENTE PISAČIH STOLOVA PO MJERI / COMPONENTS FOR CUSTOM MADE WRITING DESK

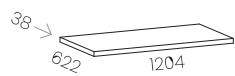

MPPL 1

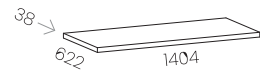

MPPL 2



MPPL



MNI

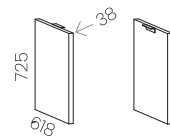

MN2(L) MN2(D)

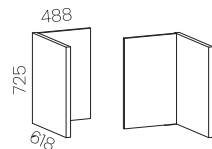

MN3(L) MN3(D)

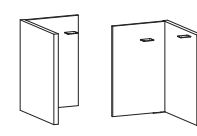

MN3K(L) MN3K(D)

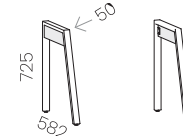

MNK(L) MNK(D)

MOŽNE BARVNE KOMBINACIJE OSNOVNIH ELEMENTOV
 MOGUĆE KOMBINACIJE BOJA OSNOVNIH ELEMENTA
 AVAILABLE COLOUR COMBINATIONS OF BASIC ELEMENTS

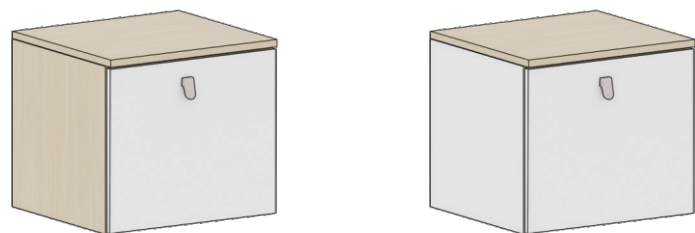

Primer:
 Primjer:
 Example:

HK/HK/BC **BC/HK/BC**

Barve korpusa / Barve pokrivne plošče / Barve front
 Boje korpusa / Boje pokrivne ploče / Boje fronta
 Frame colours / Top panel colours / Colours of doors and drawers

Barve korpusa / Boje korpusa / Frame colours

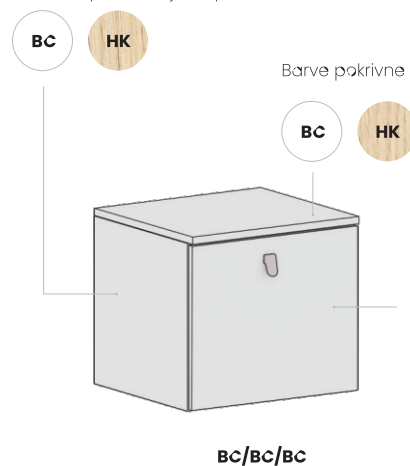

Barve pokrivne plošče / Boje pokrivne ploče / Top panel colours

Barve front / Boje fronta /
 Colours of doors and drawers

V katalogu so fronte senčene s sivo.
U katalogu su fronte zasjenjene sivom bojom.
In the catalogue, front panels are shaded with gray.

**BARVE FRONT
 / BOJE FRONTA
 / COLOURS OF DOORS
 AND DRAWERS**

V katalogu so fronte senčene s sivo.
U katalogu su fronte zasjenjene sivom bojom.
In the catalogue, front panels are shaded with gray.



hrast / hrast / oak



kašmir siva / kašmir siva / cashmere grey

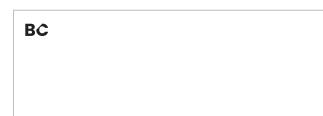

bela iveral / bijela / white

**BARVE KORPUSA
 / BOJE KORPUSA
 / FRAME COLOURS**



bela iveral / bijela / white



hrast / hrast / oak

**TKANINE
 / TKANINE
 / FABRICS**



sahara / sahara



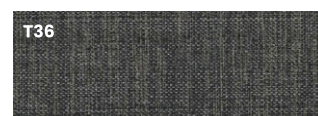

peščena / pješćana / sand

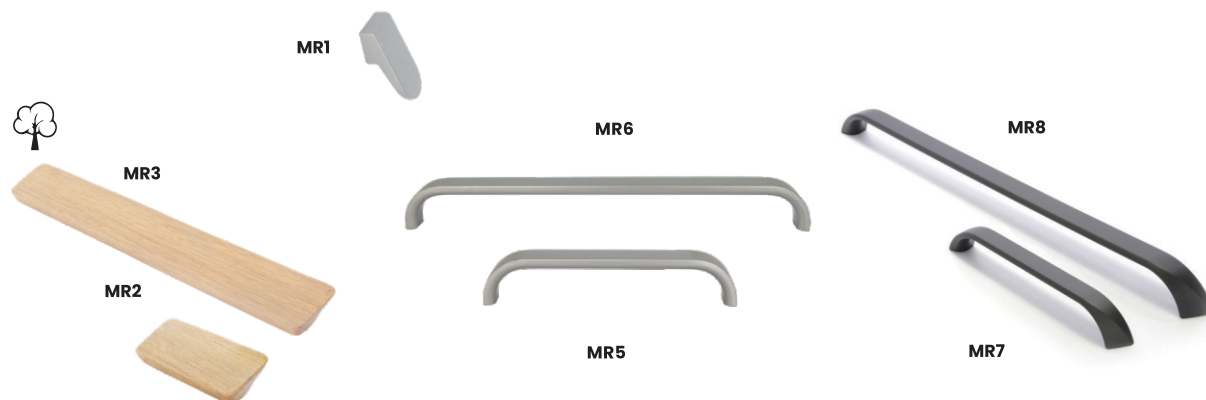

tamno siva / dark grey

ROČAJI / RUČKE / HANDLES



 *** Masivni les, ki je del spalnice, lahko barvno odstopa od melaminsko oplemenitene plošče.**
*** Masivno drvo koje je dio spavaće sobe bojom može odstupati od ploče oplemenjene melaminom.**
*** The solid wood that is a part of the bedroom may deviate in colour from the melamine-treated board.**

Dekoratívni elementi, uporabljeni pri vizualizaciji, niso del prodajnega programa Magnet.

Pridržujemo si pravico do tehničnih sprememb.

Oblikovanje pohištva:

Design team Alples, Dana Poljanec, udiá.

Tekst: Marjana Rejc, udiá.

Tisk: Sinet d.o.o., 2022

Oblikovanje: www.leparec.si,

Vizualizacije: www.arhivis.si

Dekoratívni elementi koji su upotrijebljeni kod vizualizacija nisu dio prodajnog asortimana programa Magnet.

Pridržavamo pravo

tehničkih promjena. **Dizajn**

namještaja: Design team

Alples, Dana Poljanec, arh.,

Tekst: Marjana Rejc, arh.

Tisk: Sinet d.o.o., 2022

Dizajn: www.leparec.si,

Vizualizacije: www.arhivis.si

Decorative elements used in renderings are not part of the Magnet sales programme. Alples reserves the right to change items.

Furniture design:

Design team Alples,

Dana Poljanec, arch.

Press: Sinet d.o.o., 2022

Text: Marjana Rejc, arch.

Ad&renderings: www.arhivis.si,

www.leparec.si

Barve v katalogu lahko odstopajo od originalne barve izdelkov. / Boje u katalogu mogu biti različite od stvarne boje proizvoda. / The colours in the catalogue may deviate from the original colour of the products.